



SPECIFICATIONS

CUSTOMER : _____



Product Name : 7 INCH OPEN FRAME MONITOR (CTP) SERIES

MODEL NO. : GFTM070DI800480ZI-TB

VERSION : A

DATE : 2023.12.27

CERTIFICATION : ROHS

Customer Sign	Approved By	Prepared By	Prepared By
			

晶發科技股份有限公司
GI FAR TECHNOLOGY CO., LTD .

新北市樹林區東豐街 81 號

No. 81, Dongfeng St, Shulin District, 238034, New Taipei City, Taiwan, R.O.C.

TEL: +886-2-8684-1188 FAX: +886-2-8684-8532



CONTENTS

No.	ITEM	PAGE
1	Feature	4
2	GENERAL SPECIFICATIONS	4
3	OPTICAL CHARACTERISTIC	5-7
4	TOUCH PANEL	8-9
5	INTERFACE	10
6	BLOCK DIAGRAM	11
7	RELIABILITY	12
8	PRECAUTIONS	13
9	User Manual	14-19

Appendix



1. Feature

1.1. Brand: PURPLESTAR

1.2. Model: GF070-OF

1.3. Specifications:

- 7-inch touch LCD panel
- Resolution: 800*480
- Brightness: 320cd/m²
- Built-in OSD setting buttons to adjust brightness and contrast
- Touch: RTP / CTP (Option)

1.4 Application:

- Smart Shopping cart screen
- Bus Validator screen
- MRT ticket machine screen
- Merchandise multimedia advertising screen
- Second surveillance monitor
- Vehicle central computer monitor
- HMI human-machine interface

2. GENERAL SPECIFICATIONS

Item	Contents	Unit
LCD Display Size	7.0"	
Module Structure	LCD Display + Touch + PCBA+FRAME	
LCD Display Type	TFT/TRANSMISSIVE	
LCD Display Mode	Normally Black	
Viewing direction	6 o'clock	O'Clock
Outside Dimensions	197.0 (W) * 116.0 (H) * 50.0 (T)	mm
Number of Dots	800*RGB*480	
Driver IC	TBD	
Colors	26.2 K	
Backlight Type	8*3 LEDS / White	
Module Interface Type	HDMI 、 VAG Interface (TFT)	
	USB Interface (CTP)	
System Support	Win 7-11	
Input Voltage(VDD)	DC-12V	V
Display power consumptionz	< 5W	
Temperature Range (Operation)	-20~70	°C
Temperature Range (Storage)	-30~80	°C
Mounts:	Rear mount 、 VESA mount... custom designed. (4x 4 mm Mounting Holes enabling standard M4 screws.)	



3. OPTICAL CHARACTERISTIC

Item	Symbol	Condition	Min.	Typ.	Max.	Unit	Remark
Luminance (With touch panel)	-	Normal $\theta=\Phi=0^\circ$	-	320	-	cd/m ²	Note2.5.6
Response time	Ton+Toff		-	25	50	.ms	Note2.3
Contrast ratio	CR		700	1000	-	-	Note2.4
Color chromaticity	White	Wx	0.25	0.31	0.36	-	Note2.5.6
		Wy	0.28	0.33	0.38	-	
Viewing angle	Hor.	θ_R	60	70	-	degree	Note1
		θ_L	60	70	-		
	Ver.	θ_T	50	60	-		
		θ_B	60	70	-		
Color Saturation (NTSC)	NTSC	Normal $\theta=\Phi=0^\circ$ CLE 1931	45	50	-	%	Note2.5.6
Luminance uniformity	Yu	Normal $\theta=\Phi=0^\circ$	70	75	-	%	Note2.6.7

Test Conditions:

1. $V_{cc}=3.3V$, $I_L=160mA$ (Backlight current), the ambient temperature is $25^\circ C$.
2. The test systems refer to Note 2.

Note 1: Definition of viewing angle range

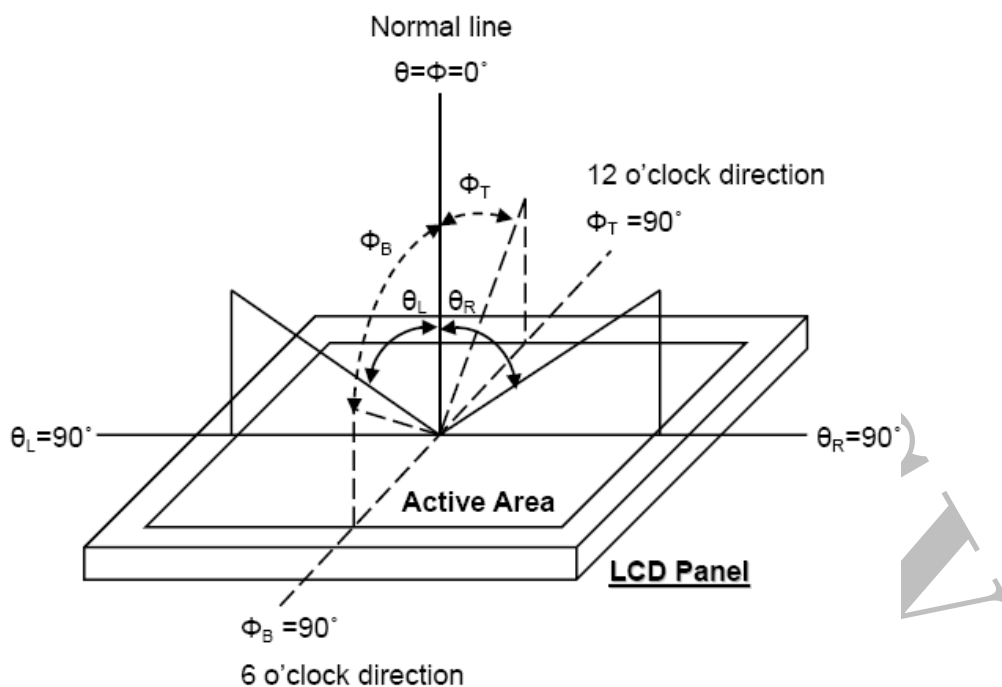

Fig. 7-1 Definition of viewing angle



Note 2: Definition of optical measurement system:

The optical characteristics should be measured in dark room. After 30 minutes operation, the optical properties are measured at the center point of the LCD screen. Optical items are measured by CS2000/Field of view: 1°/Height: 500mm.

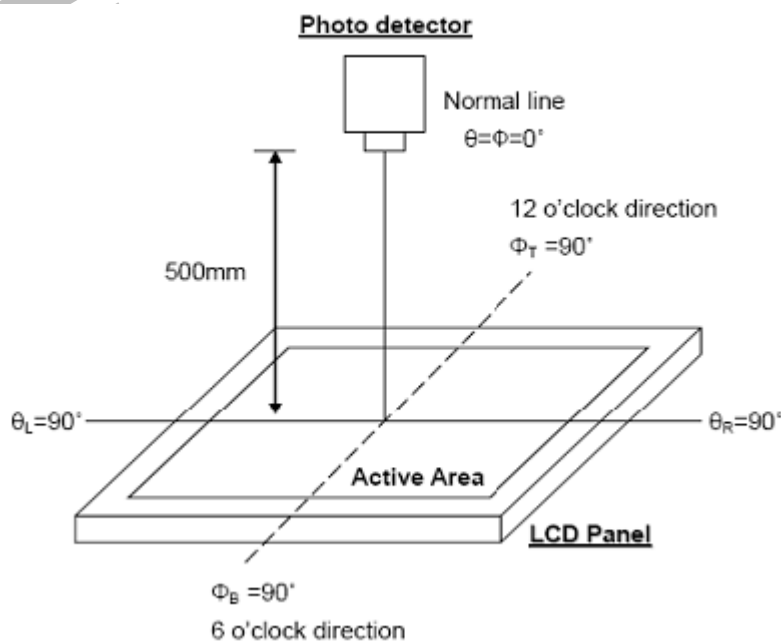

Fig.7-2 Optical measurement system setup

Note 3: Definition of Response time:

The response time is defined as the LCD optical switching time interval between “White state and “Black” state. Rise time, T_r , is the time between photo detector output intensity changed from 90% to 10% . And fall time, T_f , is the time between photo detector output Intensity changed from 10% to 90% .

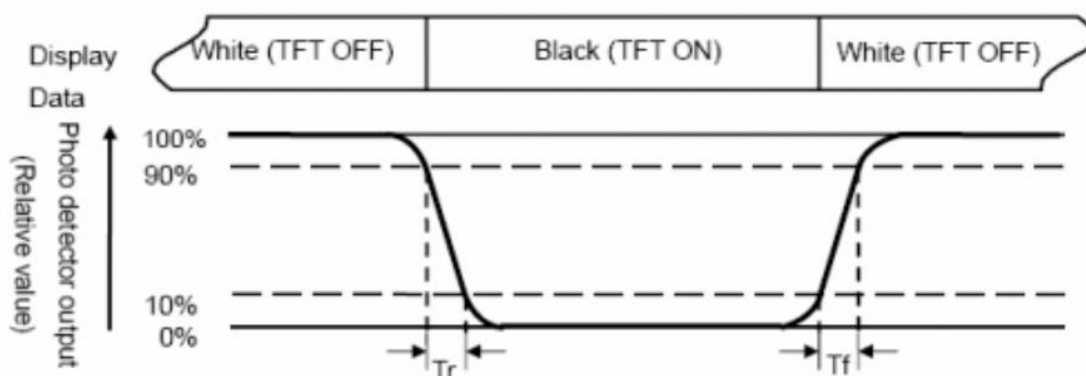

Fig. 7-3 Definition of Response time:

Note 4: Definition of contrast ratio:

The contrast ratio is defined as the following expression.

$$\text{Contrast ratio (CR)} = \frac{\text{Luminance measured when LCD on the "White" state}}{\text{Luminance measured when LCD on the "Black" state}}$$



Note 5: Definition of color chromaticity (CIE 1931)

Color coordinates measured at the center point of LCD

Note 6: All input terminals LCD panel must be ground while measuring the center area of the panel. The

LED driving condition is $I_L=160$ mA

Note 7: Definition of Luminance Uniformity

Active area is divided into 9 measuring areas (Refer to Fig. 4-4).Every measuring point is placed at the center of each measuring area.

$$\text{Luminance Uniformity } (Y_u) = \frac{B_{min}}{B_{max}}$$

L-----Active area length W----- Active area width

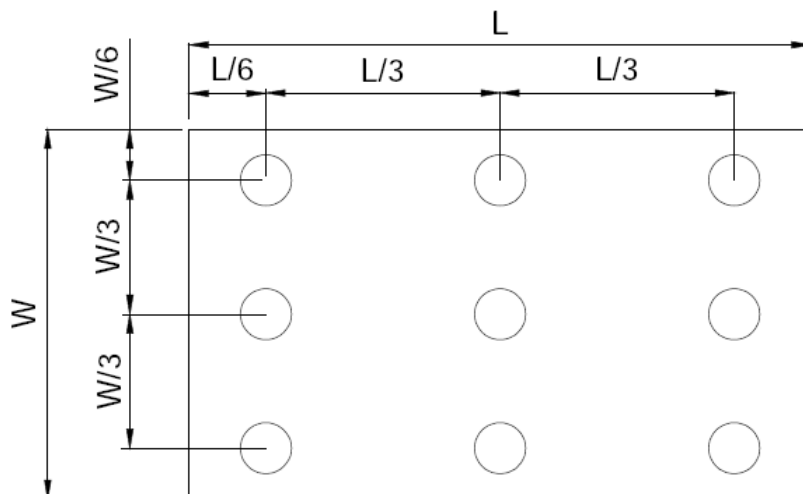

Fig. 7-4 Definition of measuring points

B_{max} : The measured maximum luminance of all measurement position.

B_{min} : The measured minimum luminance of all measurement position.



4. TOUCH PANEL (Capacitive Touch Panel)

4.1 Structure

Construction	Materials used	Comment
Structure	Cover Glass	T=0.7mm
	ITO SENSOR	T=0.55mm
IC	-	ILI2511(IIC)
SPONE	Double side Adhesive type	T=0.4mm
Connector Type	FPC	PINCH=0.5mm

4.2 Shape dimension (L=long ; W=wide ; T= thickness)

Item	Specifications	Unit
CG Outline dimension	164.7 (L) ×103.7W) ×1.45(T)	mm
SENSOR Outline dimension	163.8 (L) × 1102.8 (W)	mm
SENSOR A,A	153.4 (L) × 92.44 (W)	mm

4.3 Conditions of use and storage

Item	Value(condition)	Note
Temperature range upon operation	Humidity Range 20%~90%: (Non Condensing) Operating temperature: -20°C~70°C Storage temperature : -30°C~80°C	

4.4 Electrical property

Max voltage: 3.3 V(DC)

Total Transmittance: ≥80 %(At wavelength 550nm)

Insulation resistance: 3.3V (DC) ≥20 MΩ

Interface: I2C

Supply voltage: 2.8-3.3V

Tapping durability: ≥100,000,000 times

Surface Hardness : ≥6H



5. INTERFACE

5.1 Power DC in Connector



PIN#	Assignment
1	+ 12VDC
2	-
3	-

5.2 VGA Connector

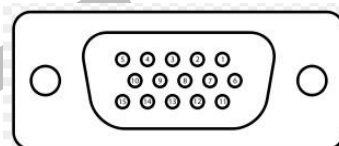

PIN#	Assignment	PIN#	Assignment	PIN#	Assignment
1	RED	6	RED_RTN	11	ID0 / RES
2	GREEN	7	GREEN_RTN	12	ID1 / SDA
3	BLUE	8	BLUE_RTN	13	HSync
4	ID2 / RES	9	KEY / PWR	14	VSynC
5	GND	10	GND	15	ID3 / SCL

5.3 HDMI Connector

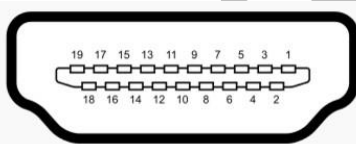

PIN#	Assignment	PIN#	Assignment
1	TMDS Data 2+	11	TMDS Clock shield
2	TMDS Data 2 shield	12	TMDS Clock-
3	TMDS Data 2-	13	CEC
4	TMDS Data 1	14	Reserved (N.C. on device)
5	TMDS Data 2 shield	15	SCL
6	TMDS Data 1	16	SDA
7	TMDS Data 0	17	DDC / CEC GND
8	TMDS Data 2 shield	18	+5V POWER
9	TMDS Data 0-	19	Hot plug detect
10	TMDS Clock+		



5.4 USB Connector (Touch)

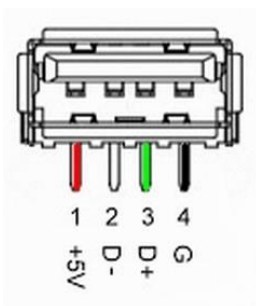

PIN#	Assignment
1	+5V
2	D-
3	D+
4	GND

OSD Function Description

Function	Description
Volume / Done	Hotkey is Volume / move the option
Backlight / Up	Hotkey is Backlight / move the option
	Turn on and off power
Menu / Confirm	On no signal Press the button to select from different video sources(VGA · HDMI)/ Press to display the OSD / move the menu.
Auto / Exit	Auto Adjust /Leave the menu
LED	ON : Green No Singal : Red OFF : Orange

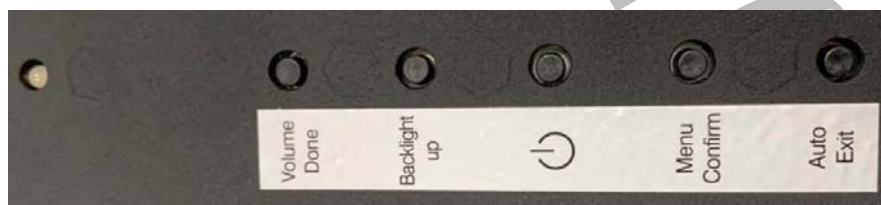



6. BLOCK DIAGRAM

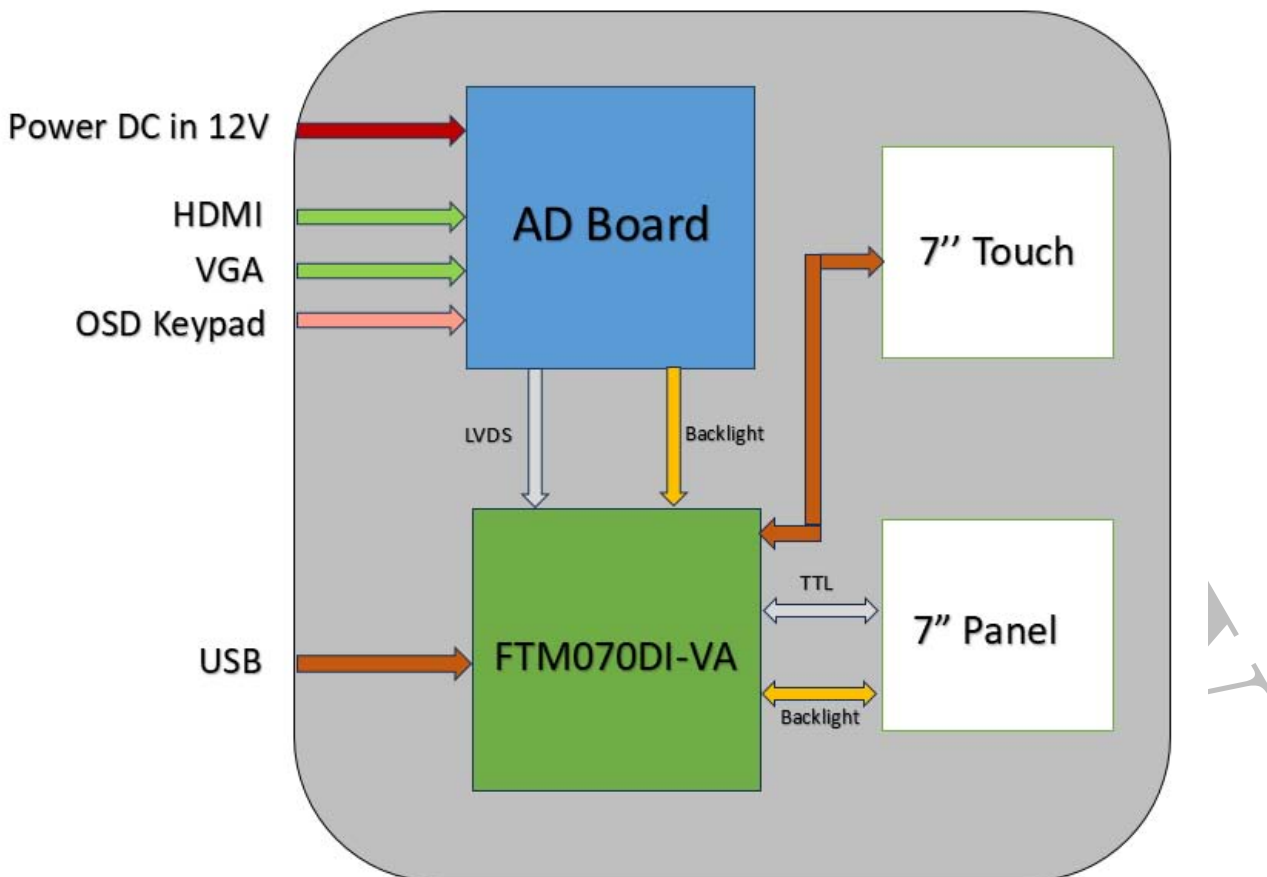
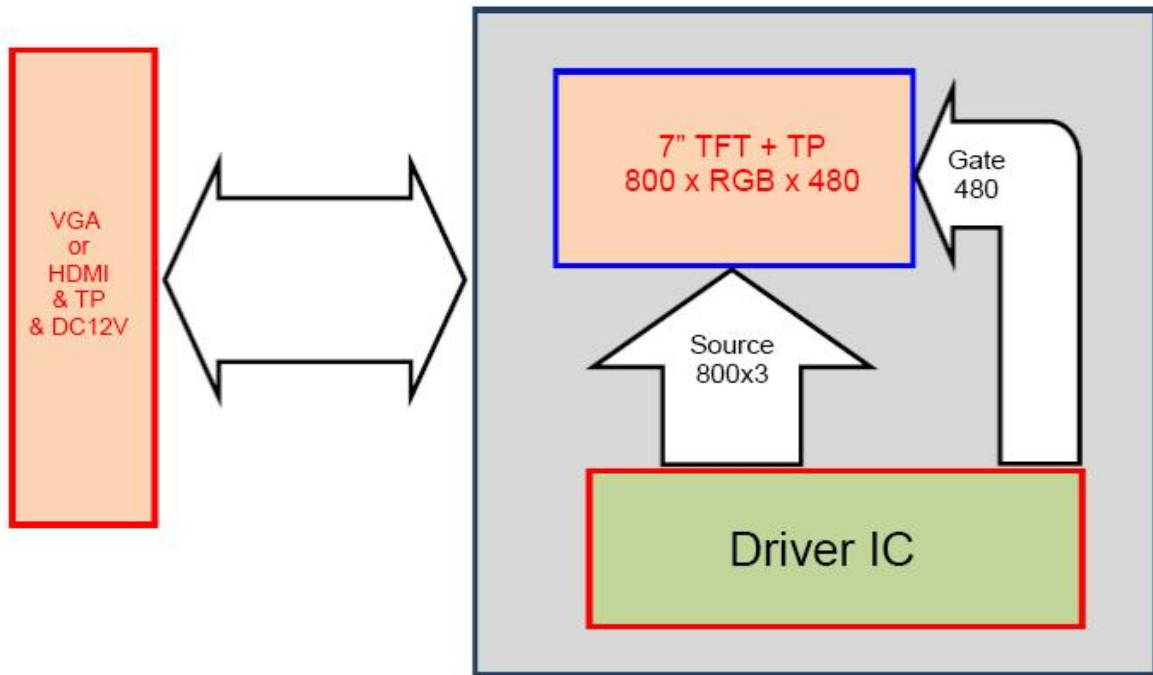



7. RELIABILITY

NO.	ITEM	CONDITION		STANDARD	NOTE
1	High Temp. Storage	80°C	120 hrs	Appearance Without defect	
2	Low Temp. Storage	-30°C	120 hrs	Appearance Without defect	
3	High Temp. & High Humi. Storage	40°C 90% RH	120 hrs	Appearance Without defect	
4	High Temp. Operating Display	70°C	120 hrs	Appearance Without defect	
5	Low Temp. Operating Display	-20°C	120 hrs	Appearance Without defect	
6	Thermal Shock	-20°C, 30min. → 70°C, 30min. (1cycle)		Appearance Without defect	10 cycles

** Dissipation current, contrast and display functions

** Polarizing filter deterioration, other appearance defects

** The function test shall be conducted after 4hours storage at the normal temperature and humidity after remove from the test chamber.



8. PRECAUTIONS

Please pay attention to the following when you use this TFT LCD module.

8.1 OPERATING PRECAUTIONS

- (1) The spike noise causes the mis-operation of circuits. It should be lower than following voltage : $V=\pm 200\text{mV}$ (Over and under shoot voltage)
- (2) Response time depends on the temperature. (In lower temperature, it becomes longer.)
- (3) Brightness depends on the temperature. (In lower temperature, it becomes lower) And in lower temperature, response time (required time that brightness is stable after turned on) becomes longer.
- (4) Be careful for condensation at sudden temperature change. Condensation makes damage to polarizer or electrical contacted parts. And after fading condensation, smear or spot will occur.
- (5) When fixed patterns are displayed for a long time, remnant image is likely to occur.
- (6) Module has high frequency circuits. Sufficient suppression to the electromagnetic interference shall be done by system manufacturers. Grounding and shielding methods may be important to minimize the interference.

8.2 ELECTROSTATIC DISCHARGE CONTROL

Since a module is composed of electronic circuits, it is not strong to electrostatic discharge. Make certain that treatment persons are connected to ground through wristband etc. And don't touch interface pin directly.

8.3 PRECAUTIONS FOR STRONG LIGHT EXPOSURE

Strong light exposure causes degradation of polarizer and color filter.

8.4 STORAGE

When storing modules as spares for a long time, the following precautions are necessary.

- (1) Store them in a dark place. Do not expose the module to sunlight or fluorescent light. Keep the temperature between 5°C and 35°C at normal humidity.
- (2) The polarizer surface should not come in contact with any other object. It is recommended that they be stored in the container in which they were shipped.

8.5 HANDLING PRECAUTIONS FOR PROTECTION FILM

- (1) When the protection film is peeled off, static electricity is generated between the film and polarizer. This should be peeled off slowly and carefully by people who are electrically grounded and with well ion-blown equipment or in such a condition, etc.
- (2) The protection film is attached to the polarizer with a small amount of glue. Is apt to remain on the polarizer. Please carefully peel off the protection film without rubbing it against the polarizer.
- (3) When the module with protection film attached is stored for a long time, sometimes there remains a very small amount of glue still on the polarizer after the protection film is peeled off.
- (4) You can remove the glue easily. When the glue remains on the polarizer surface or its vestige is recognized, please wipe them off with absorbent cotton waste or other soft material like chamois soaked with normal-hexane.

8.6 QUALITY WARRANTY PERIOD

Within one year after shipment date. (excluding abnormal usage way and abnormal environments.)



9. User Manual

Display Setting

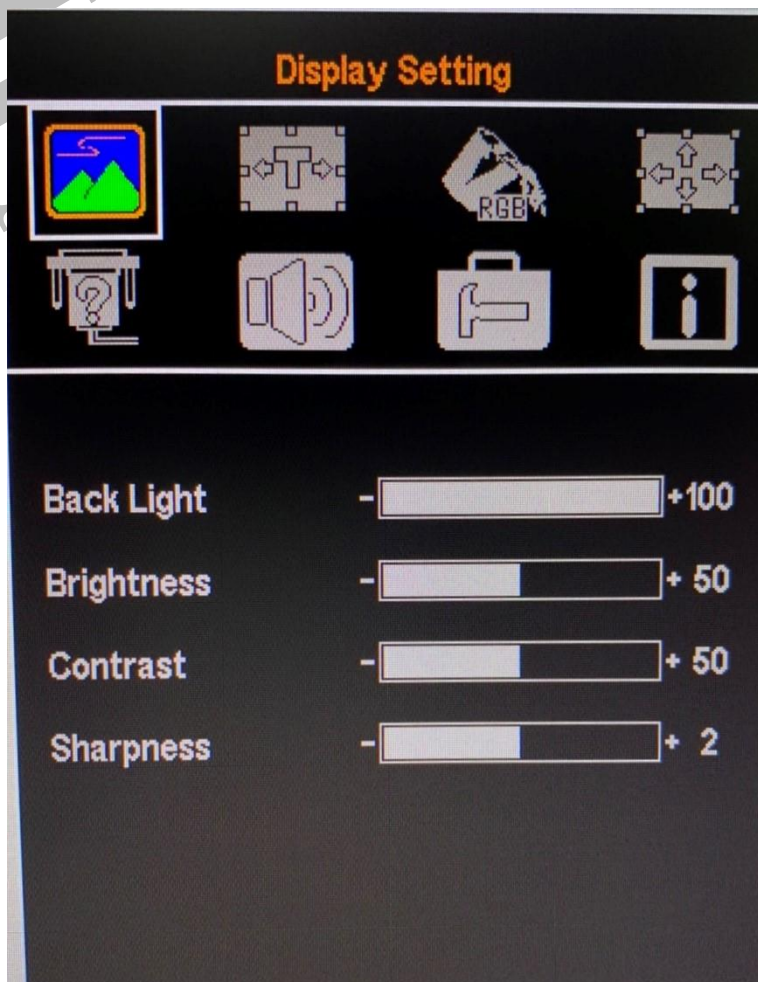

MENU>Display Setting		Description
Back Light	0-100	Backlight Adjustment
Brightness	0-100	Backlight Adjustment
Contrast	0-100	Contrast from Digital-register.
Sharpness	0-4	Sharpness Adjustment



Image Setting

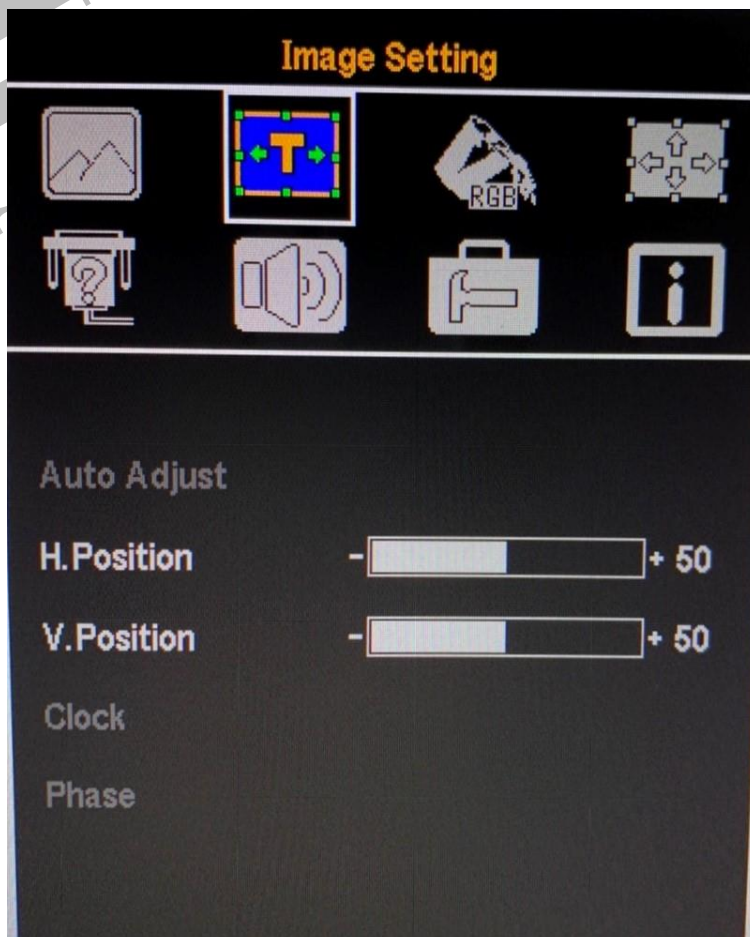

MENU>NEXT MENU> Image Setting		Description
Auto Adjust		Adjust the Screen on VGA source
H.Position	0-100	Adjust the horizontal position of the Frame
V.Position	0-100	Adjust the vertical position of the Frame
Clock		Adjust the Clock
Phase		Adjust the Phase



Color Setting

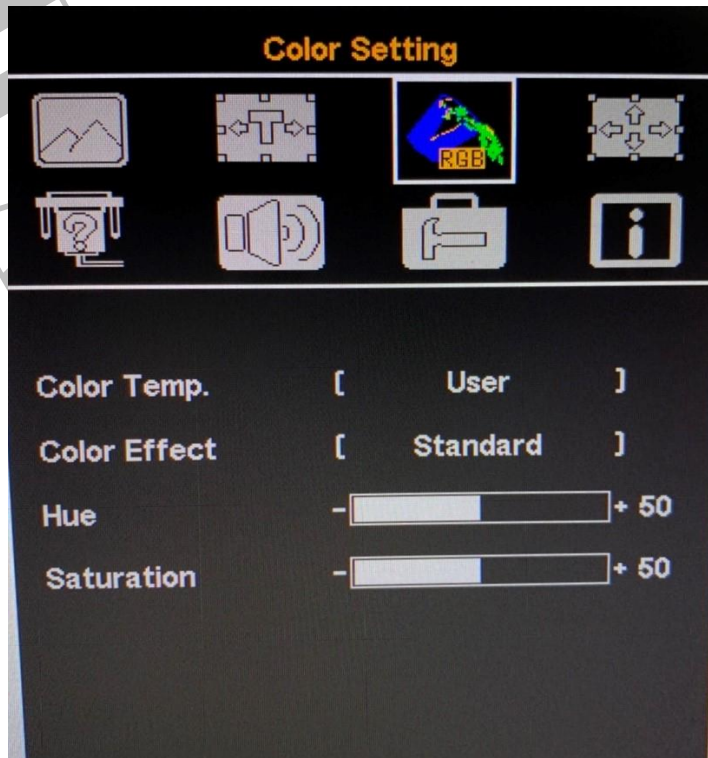

MENU>NEXT MENU>Color Setting		Description
Color Temp	User (Default)	R : 128 ; G : 128 ; B : 128
	Cool	Default
	Warm	Default
Color Effect	Standard (Default)	
	Game	
	Movie	
	Photo	
	Vivid	
	User	
Hue	0-100	Adjust Hue on HSV
Saturation	0-100	Adjust Saturation on HSV



Enhanced Setting

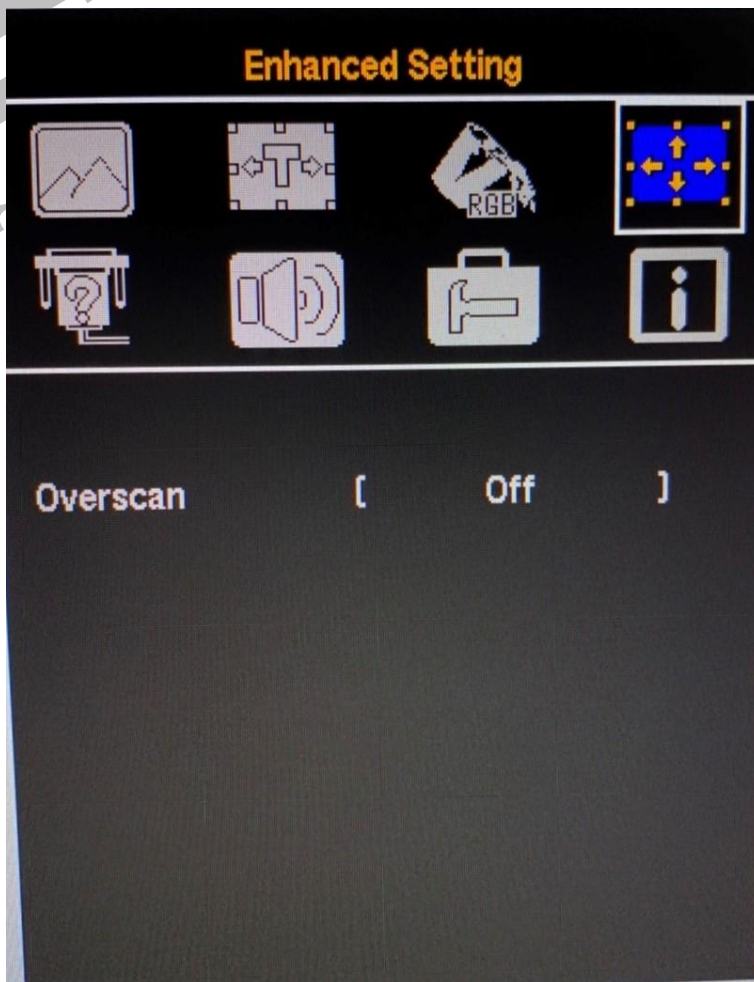

MENU>NEXT MENU> Enhanced Setting		Description
Overscan	Off(Default)	



Input Source

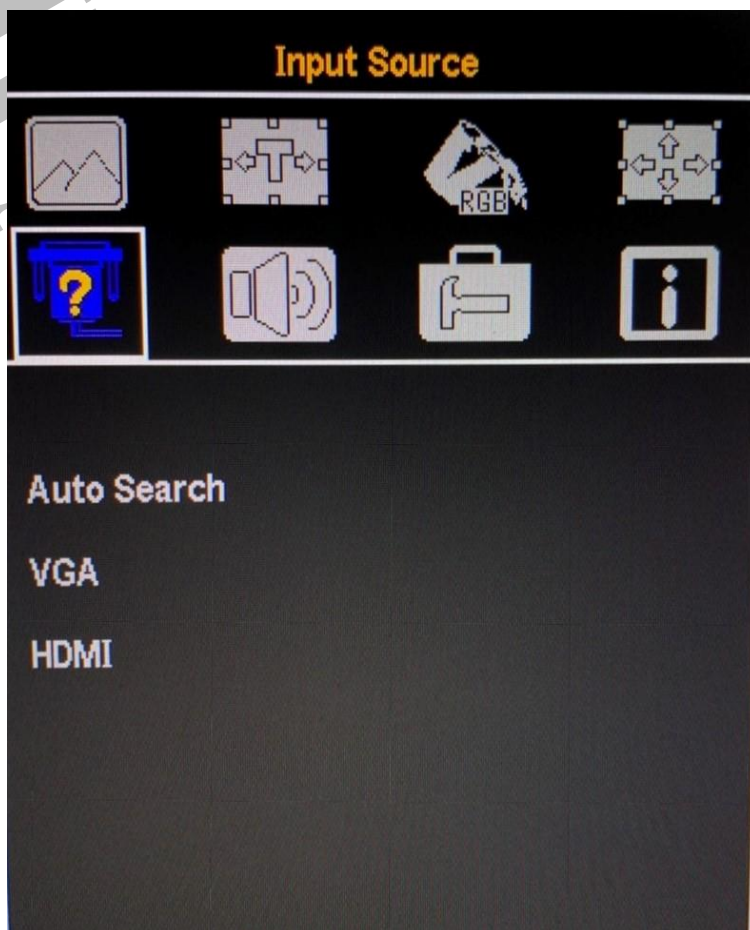

MENU>NEXT MENU> Input Source		Description
Auto Search	(Default)	Auto detect Source
VGA		Fixstion on VGA
HDMI		Fixstion on HDMI



OSD Menu

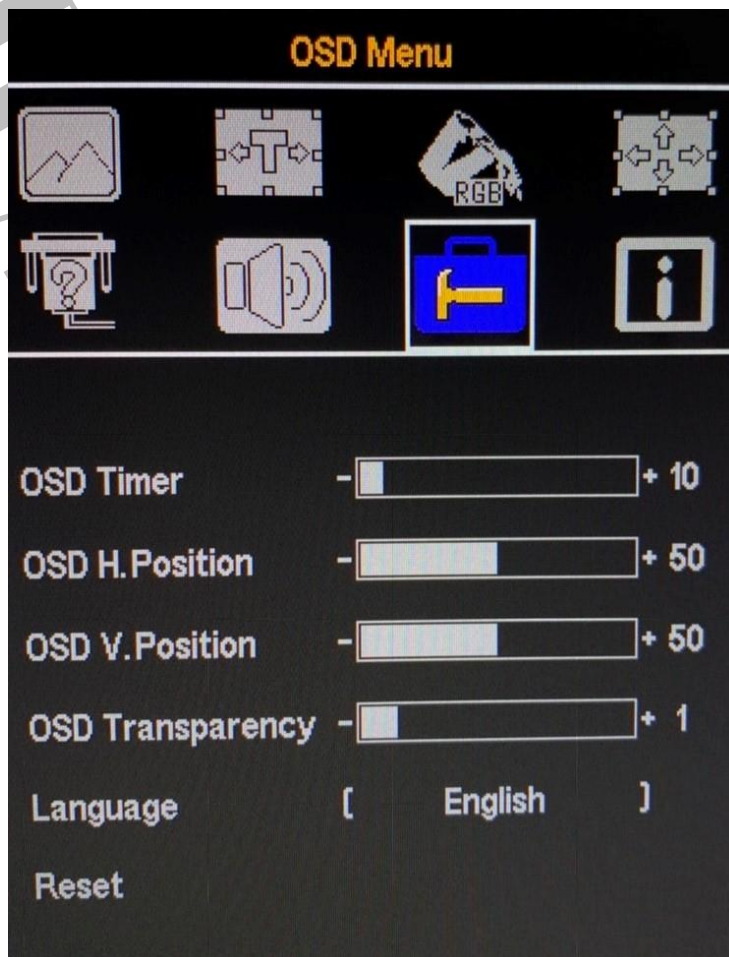

MENU>NEXT MENU> Audio		Description
OSD Timer	0-100	Adjust the Volume
OSD H.Position	0-100	Adjust OSD Menu H.Position
OSD V.Position	0-100	Adjust OSD Menu V.Position
OSD Transoarency	0-100	Adjust OSD Menu Transoarency
Language	English(Default) Français Deutsch Español 繁體中文	
Reset		All Setting Load Default



Appendix

- VGA cable x 1
- USB cable x 1
- United States Power Cords x 1
- GST60A12-PPO x 1
- P4*6 ISO NI+ Self-Locking x 8pcs → VESA use
- Side Rack x 2 → OF Lock directly to the module



**Sample photos



RoHS

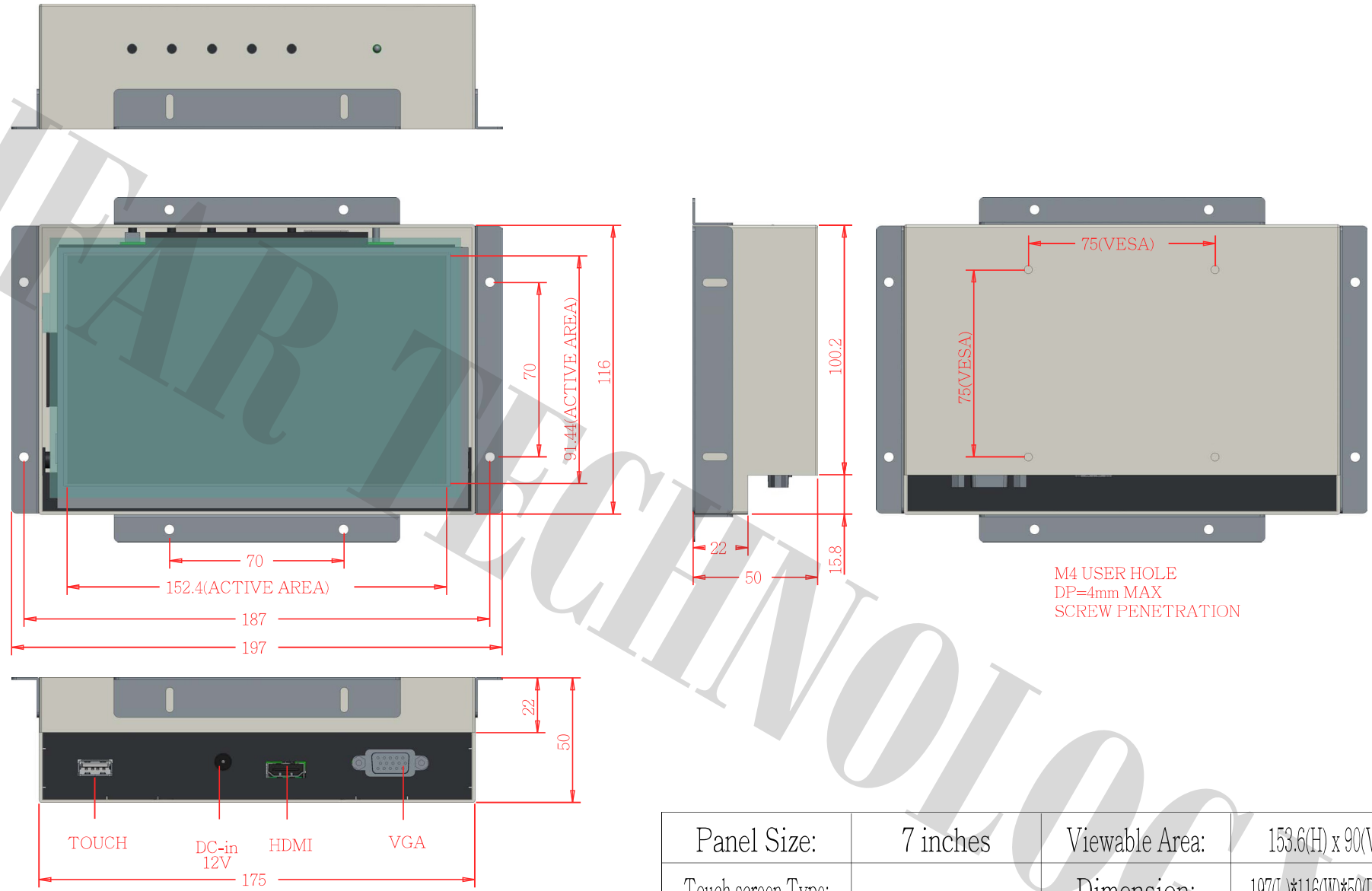

Panel Size:	7 inches	Viewable Area:	153.6(H) x 90(V)
Touch screen Type:		Dimension:	197(L)*116(W)*50(D)mm

日期	版本	修改内容

晶發科技股份有限公司
 GI FAR TECHNOLOGY CO., LTD

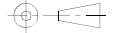
DATE	2023.09.12	REV	00	DRAWING NO. :	R01-202308001
UNIT : mm	Product :				
SCALE : 1/1	DRAWN :	Hazel	CHECKED :	Sidney	
					PAGE : 1/1